

COMMERCIAL HEAVY DUTY

Product Specifications

Shape	Elongated
Seat Material	Polypropylene
Seat Form	Open front
Commercial Hinge	Yes
Bolt Material	Stainless steel
Hardware Material	Stainless Steel
Check Hinge	Yes
Cover	No
Custom Gasket	Yes
Color	White

Warranty 1 year limited warranty

Available Colors White,

Features

ADA Compliant Raised Seat

ADA compliant 3" medical assistance raised toilet seat.

Commercial Hinge

Includes commercial grade hinges. One piece solid metal hinge pin and bolt over molded with plastic.

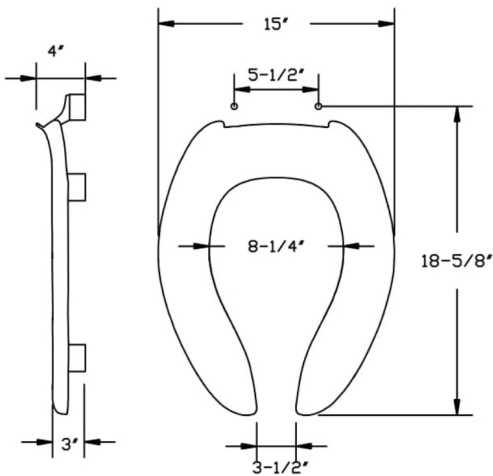

Dimensions shown are nominal and may vary within a range of tolerance. Product specifications are subject to change without notice.